

Nordbotten / 170 / 18

Norrbottnen//70/18
Grundplan

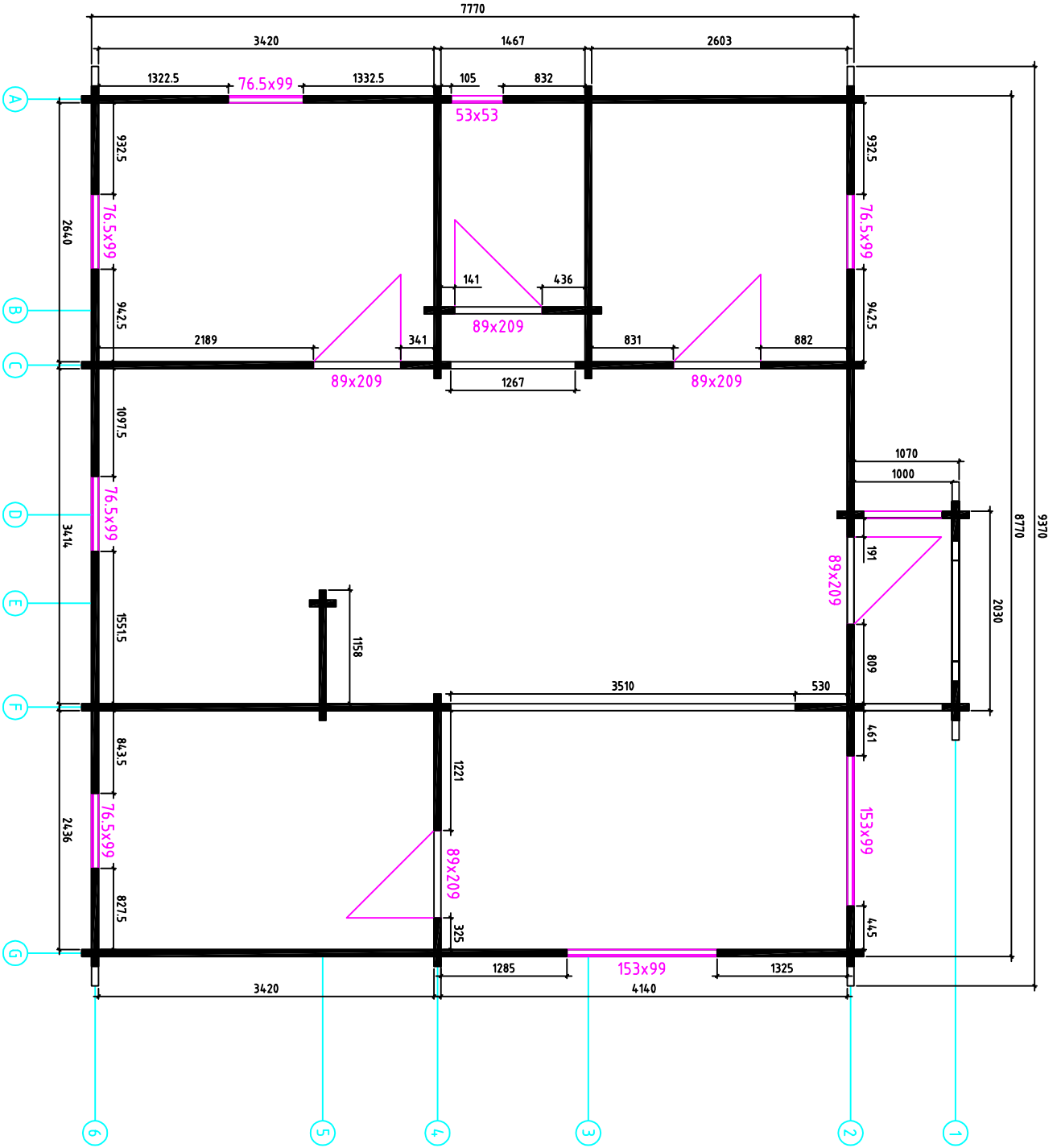

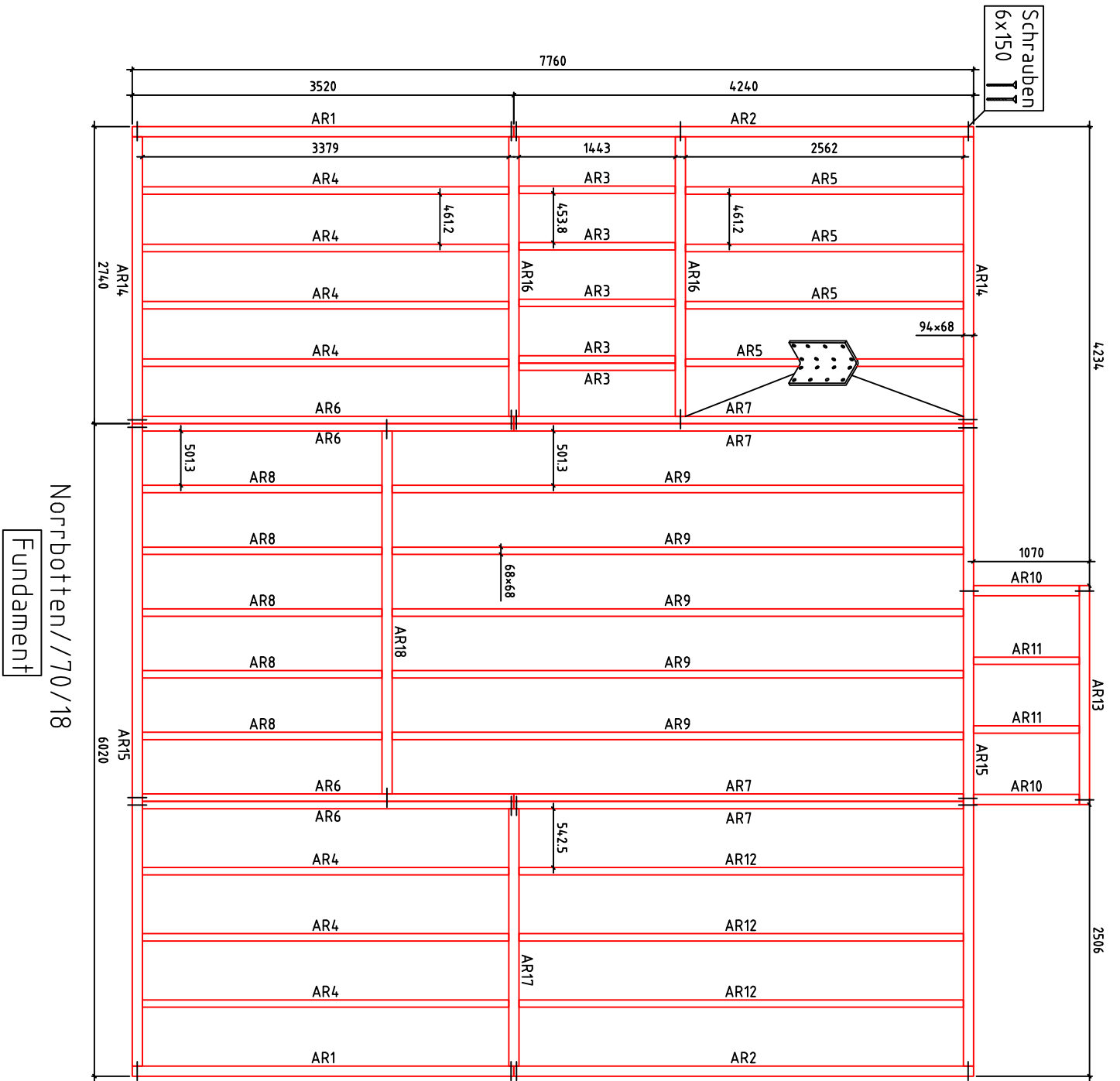

Norrbotten//70/18
Fundament

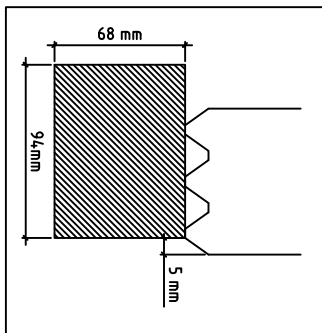

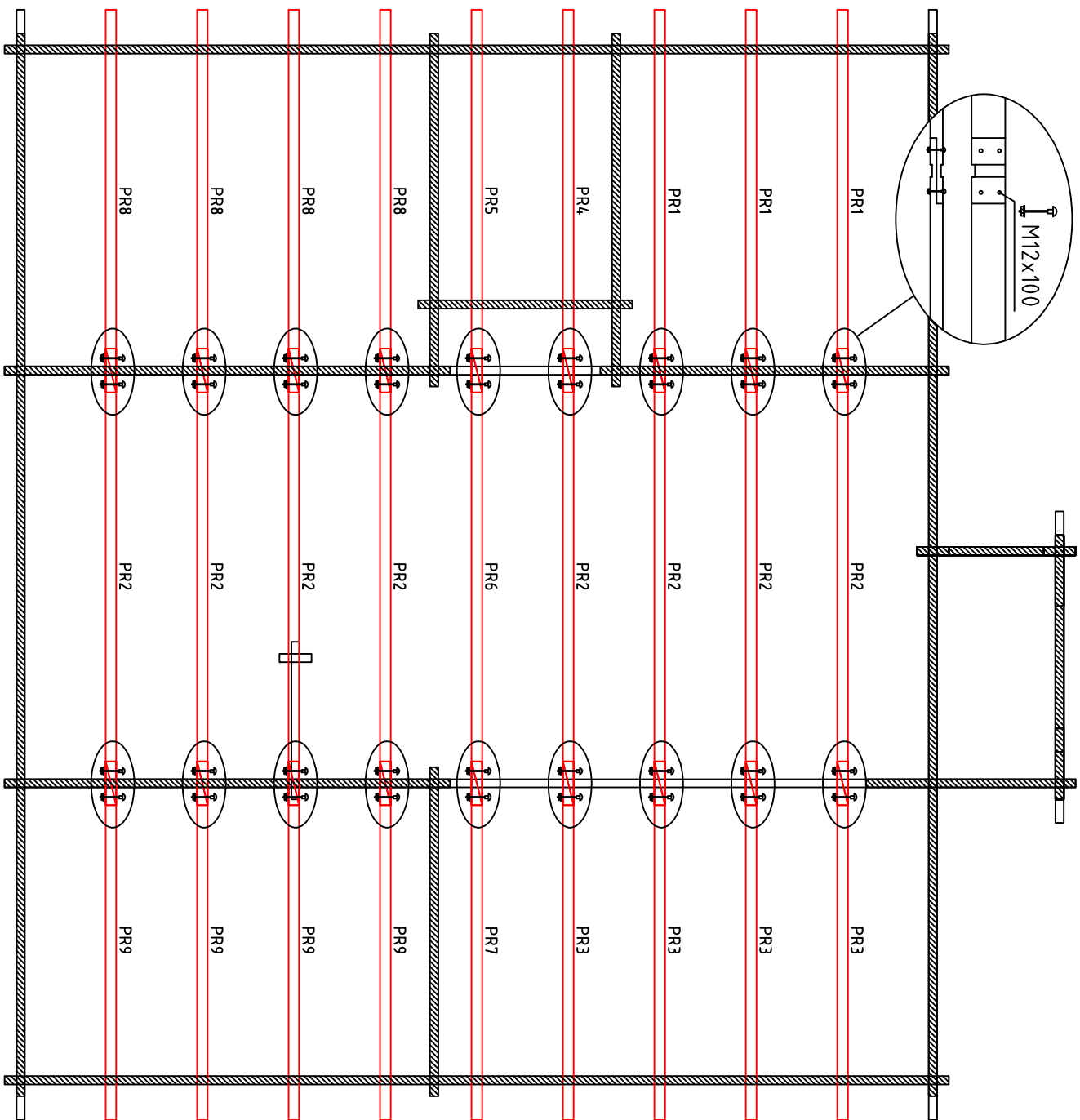

Norbotten//70/18

Dachbalken

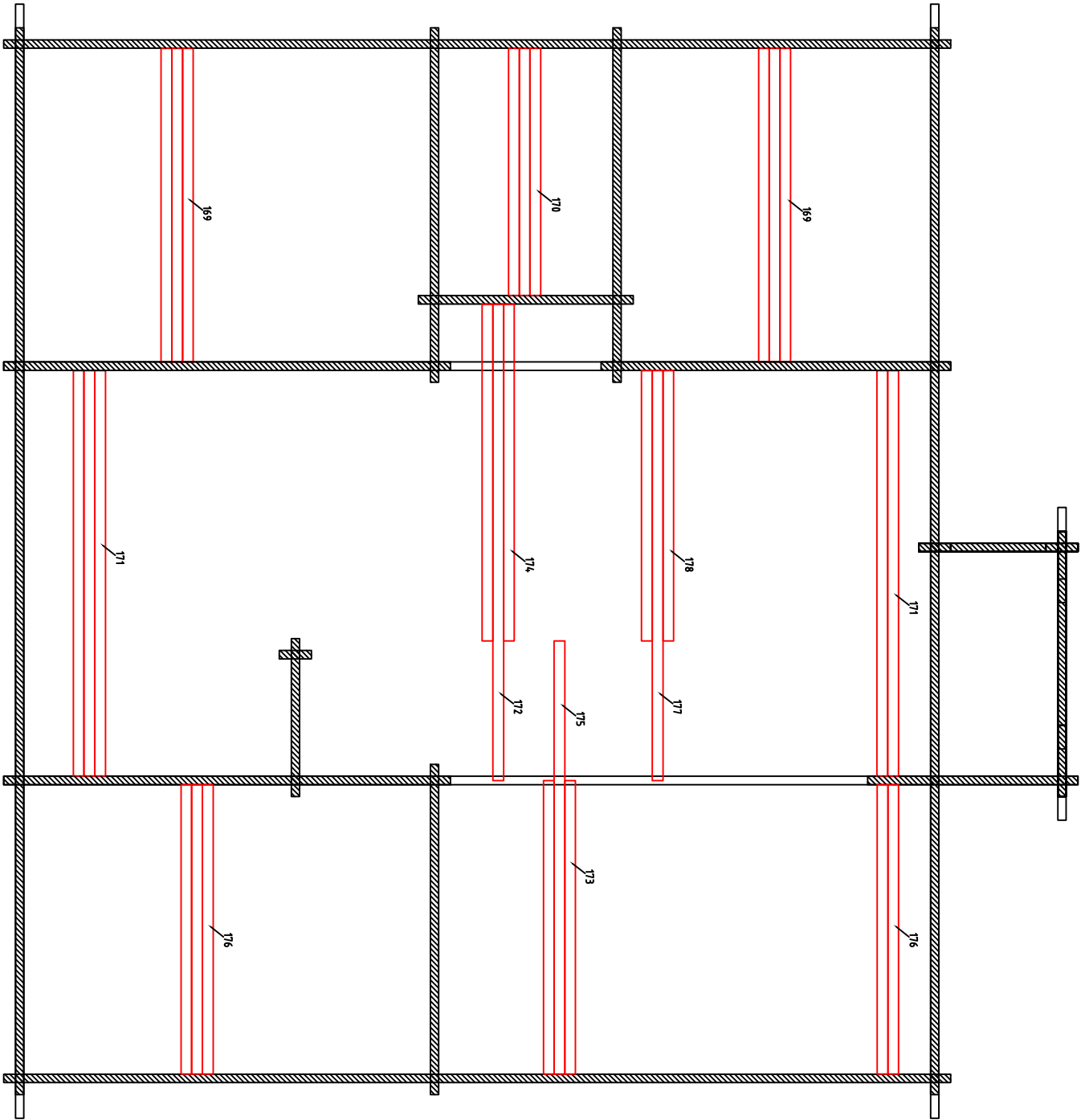

Norrbottnen//70/18

Fussbodenbretter

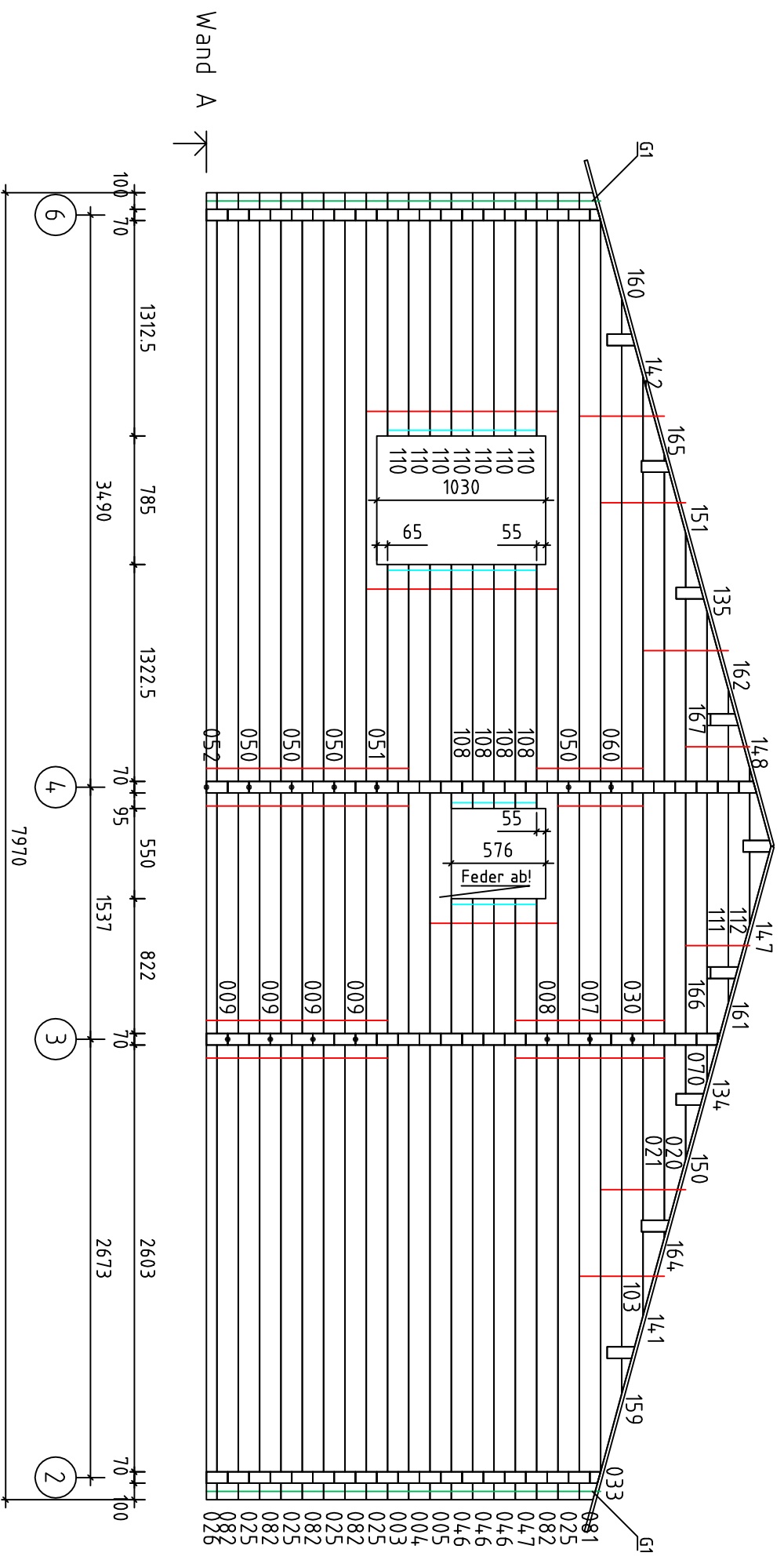

Norrbottnen//70/18

6

4

3

2

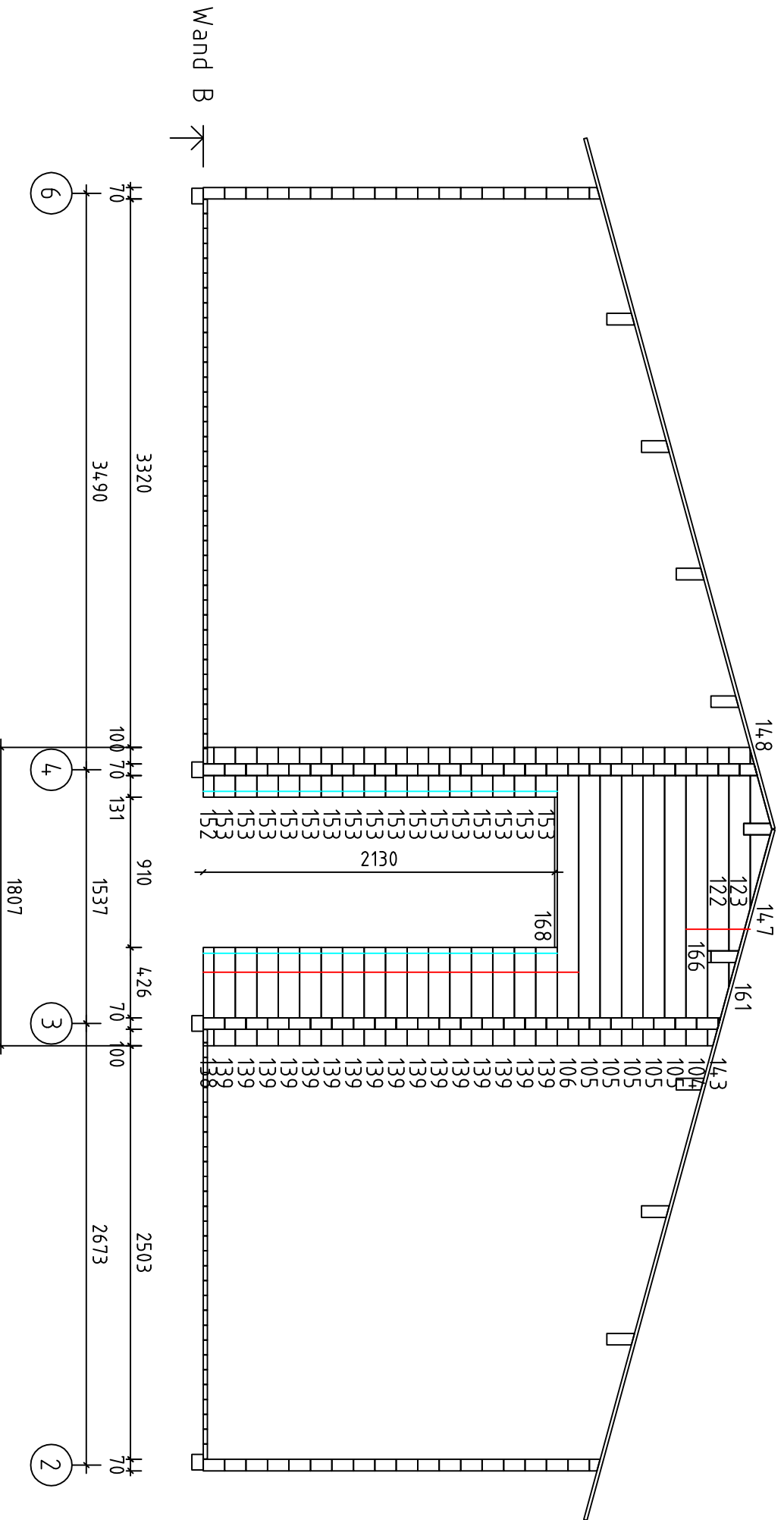

Norbotten // 70 // 18

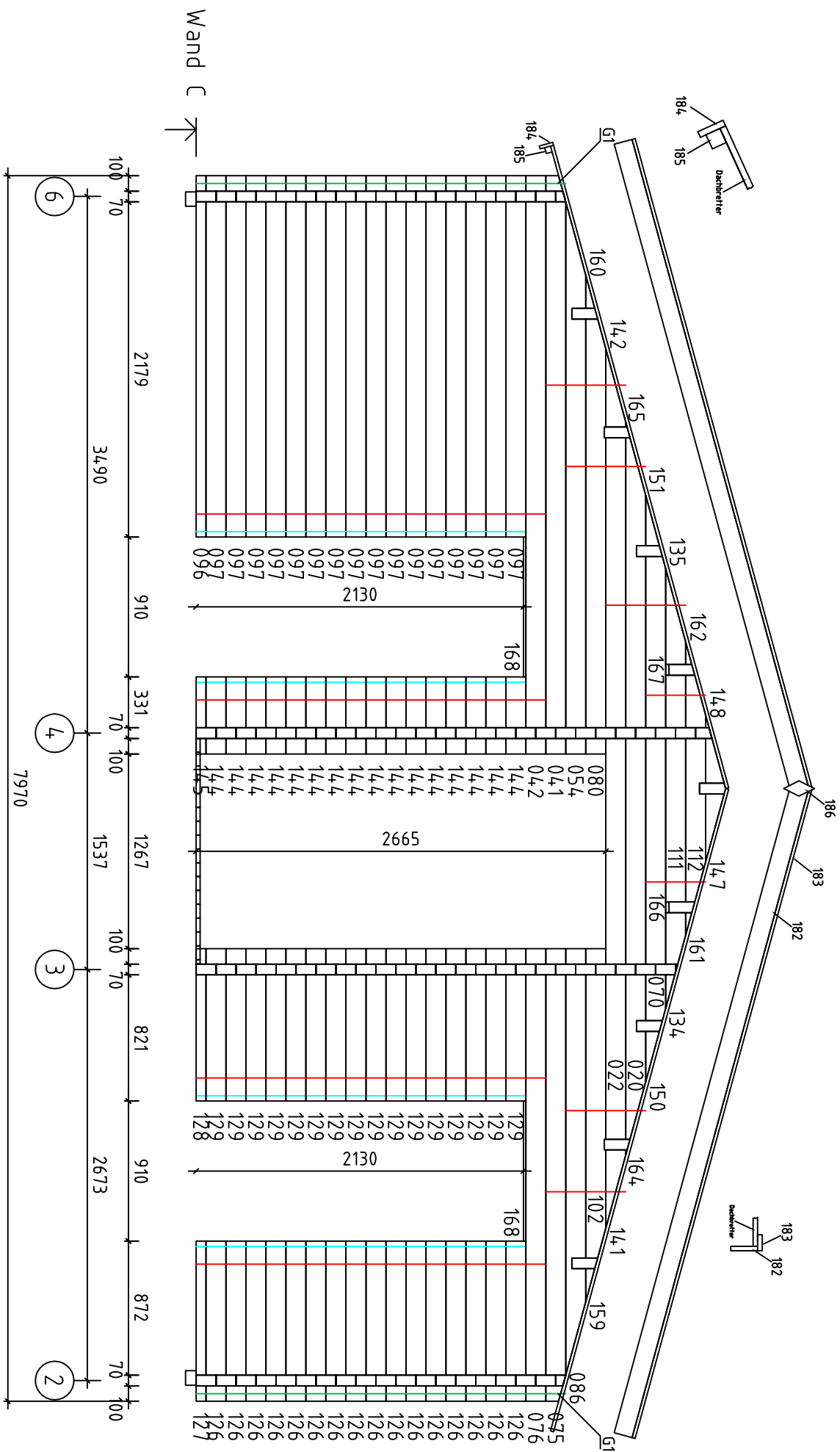

Norrbotten // 70 / 18

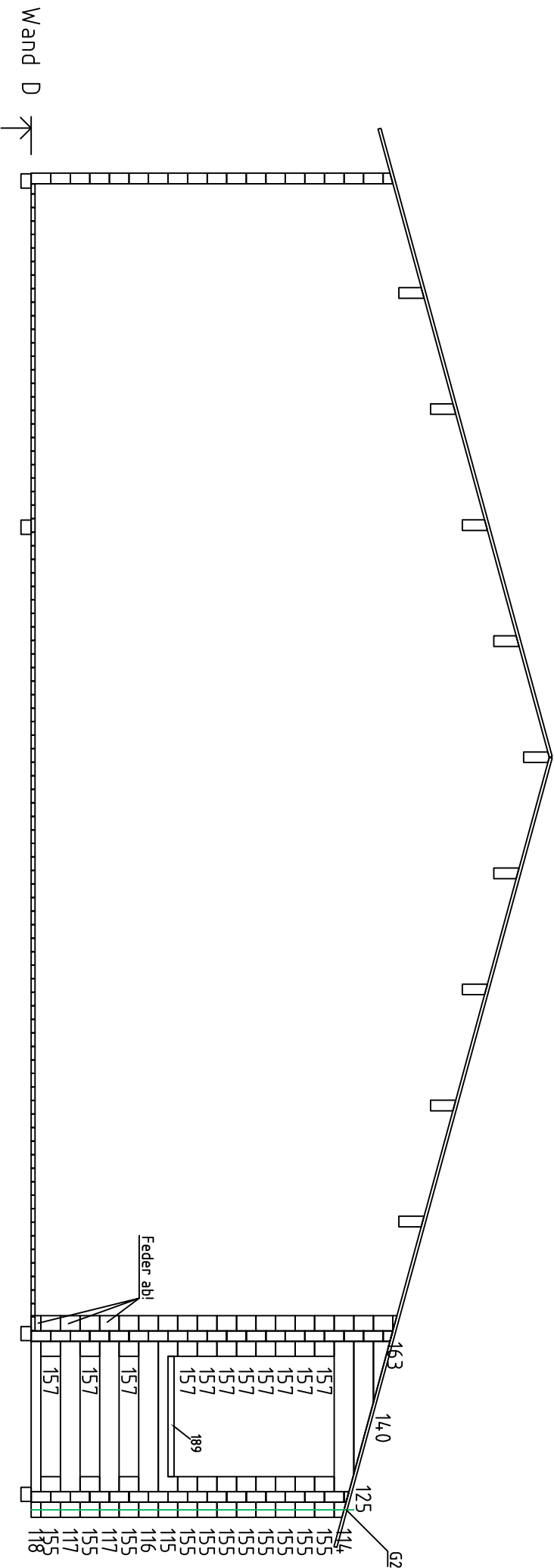

Nordboften//70/18

Wand E

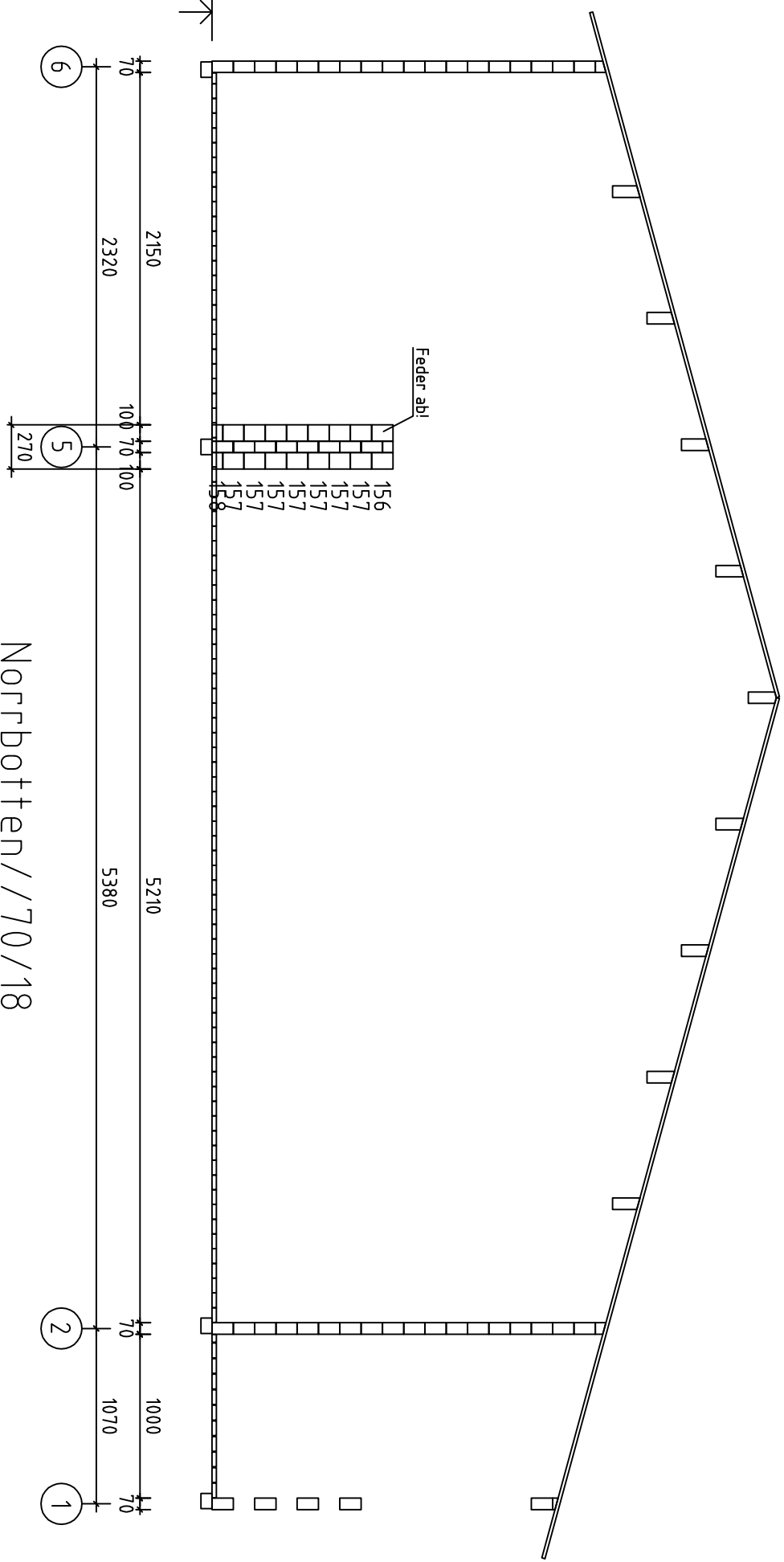

Norrbotten//70/18

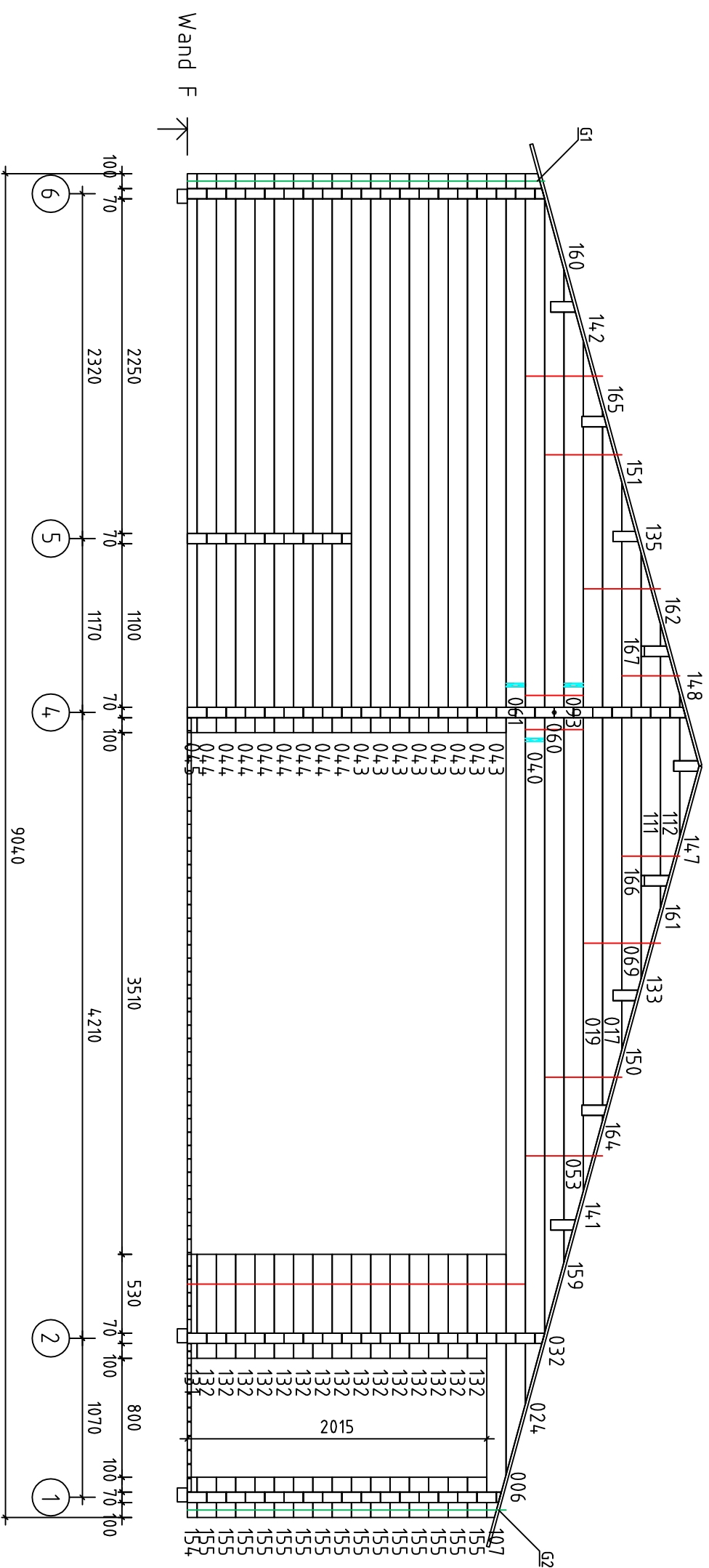

Norrbotten//70/18

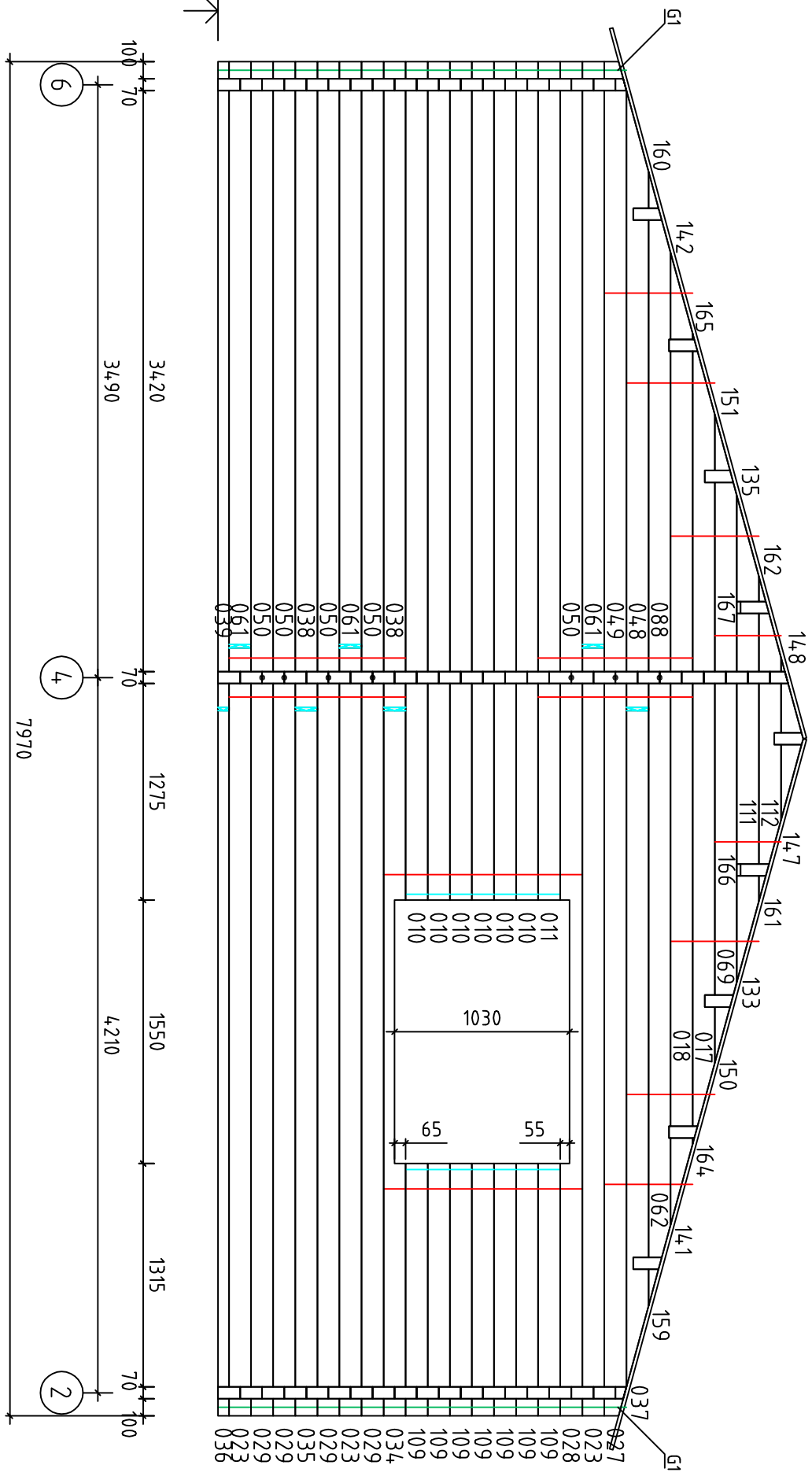

Norrbotten//70/18

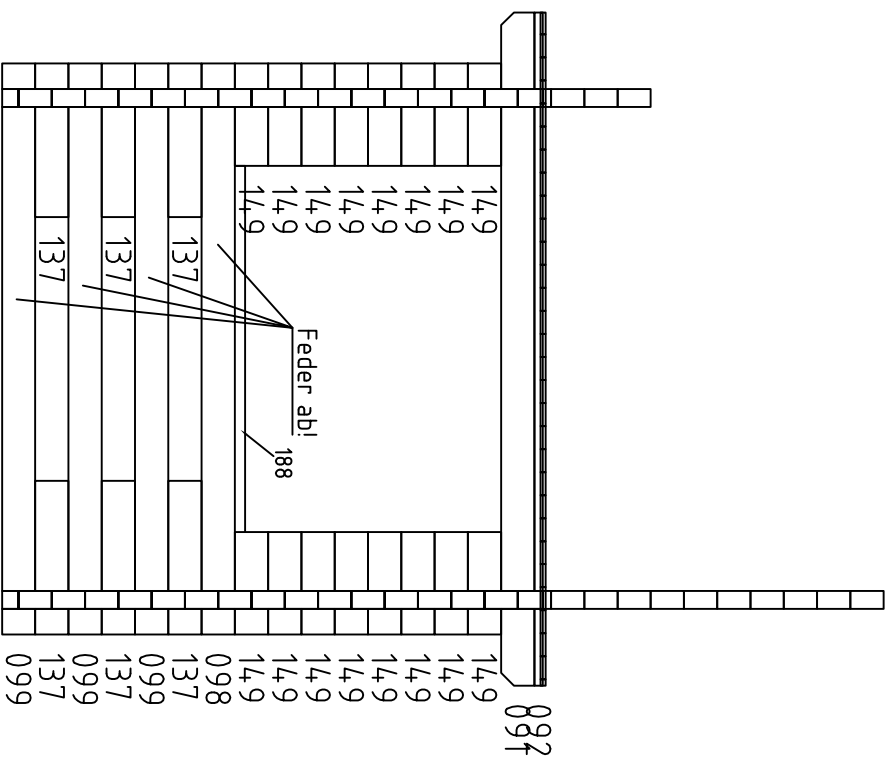

Wand 1 ↗

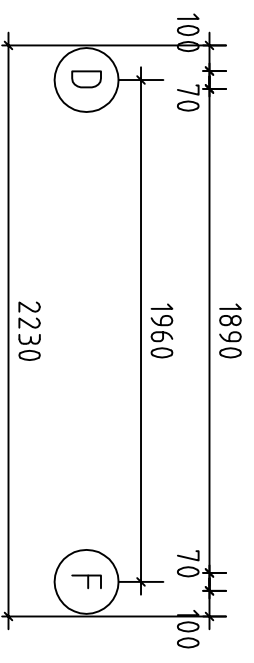

Norrbottnen//70/18

Wand 2 ↗

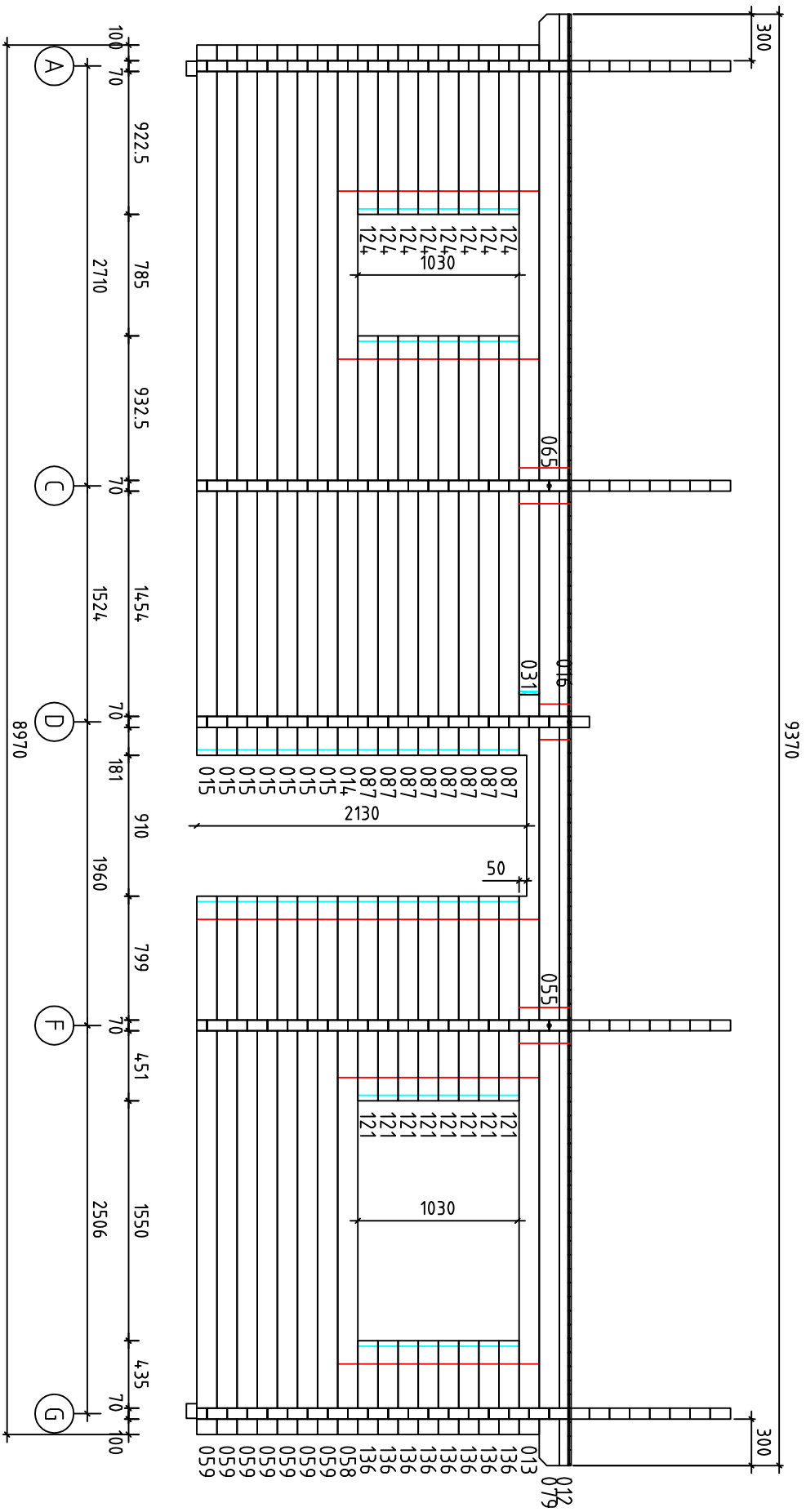

Norbotten//70/18

Wand 3 ↗

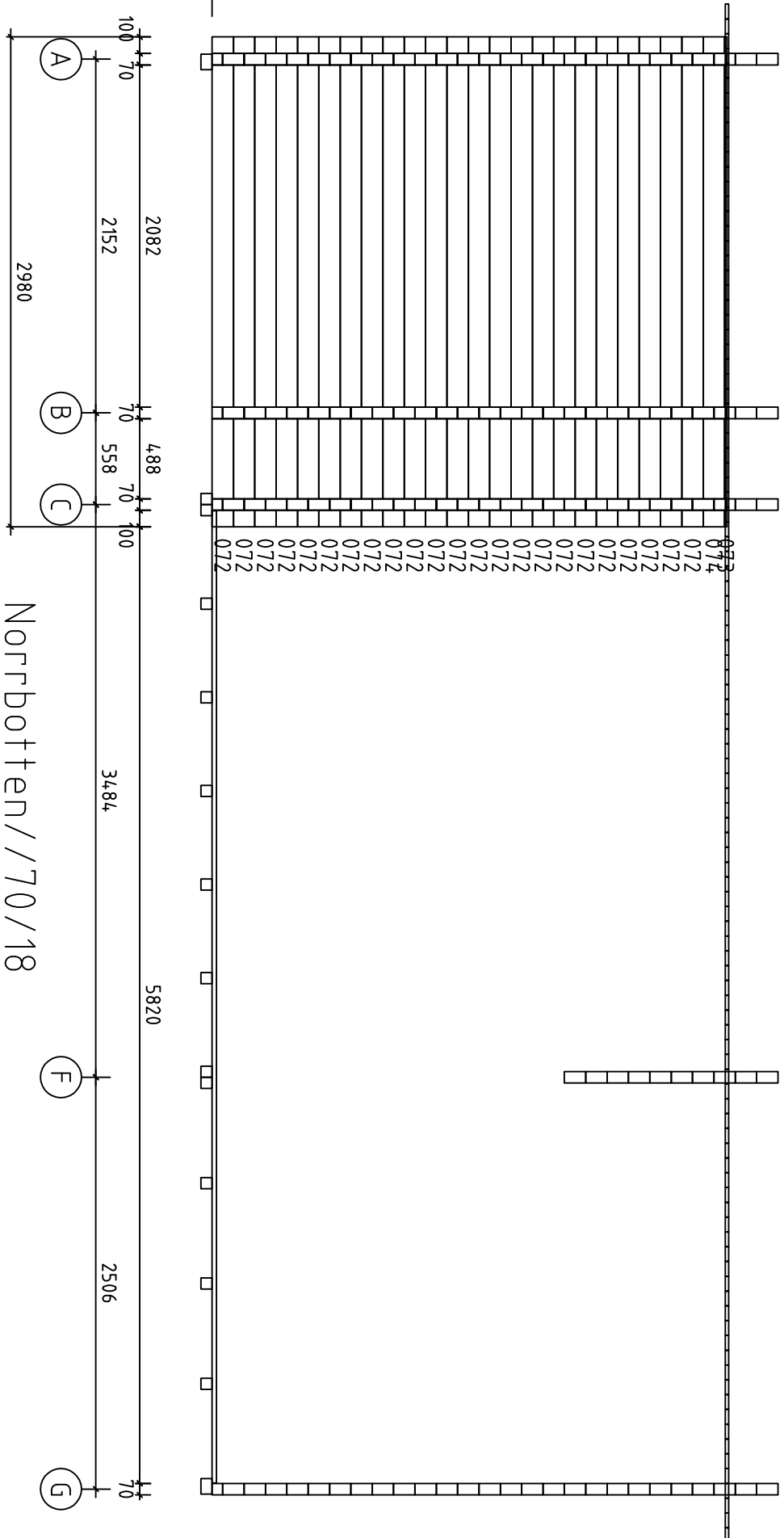

Wand 4 ↗

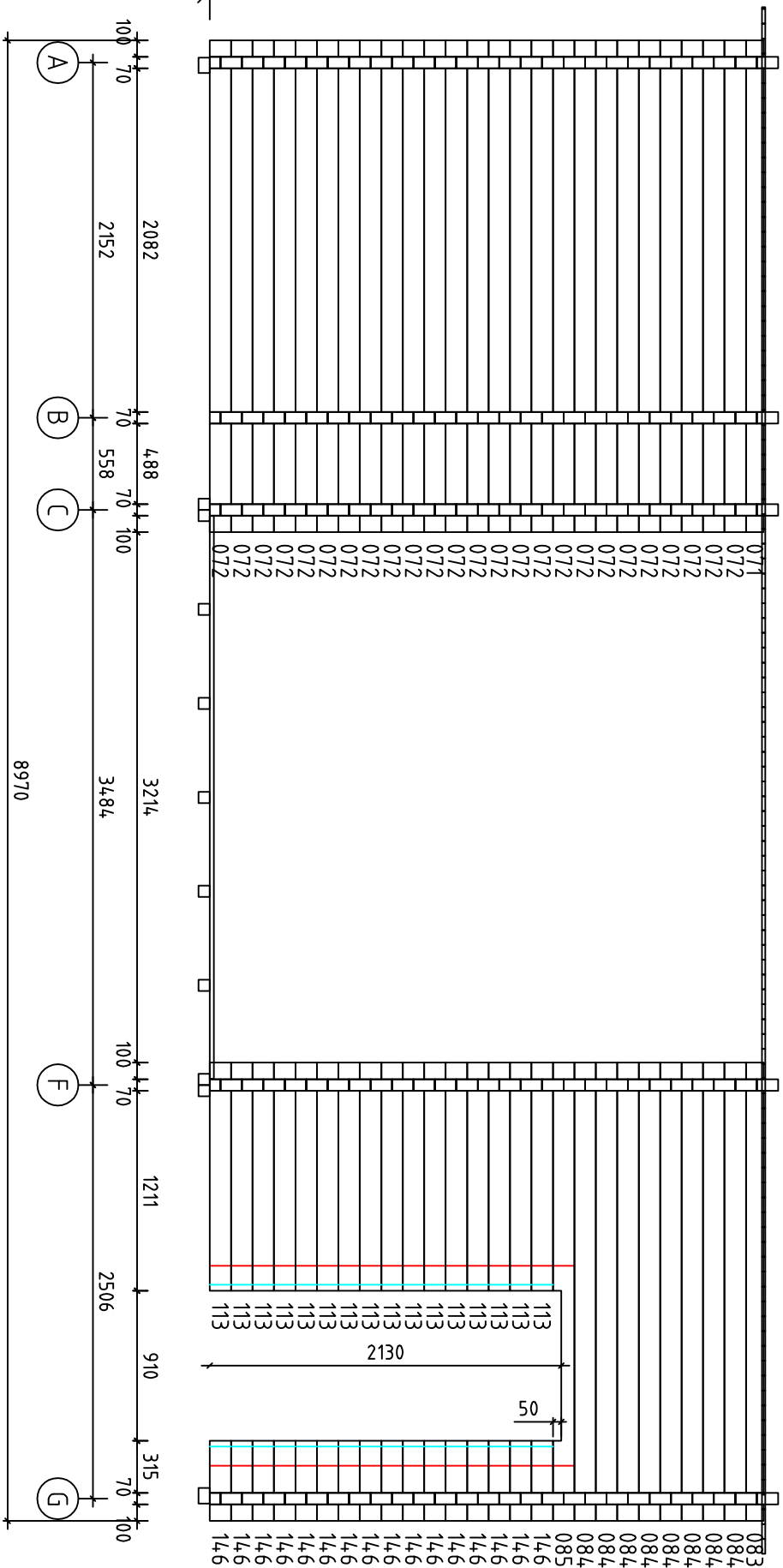

Norrbotten // 70 / 18

Wand 5 ↗

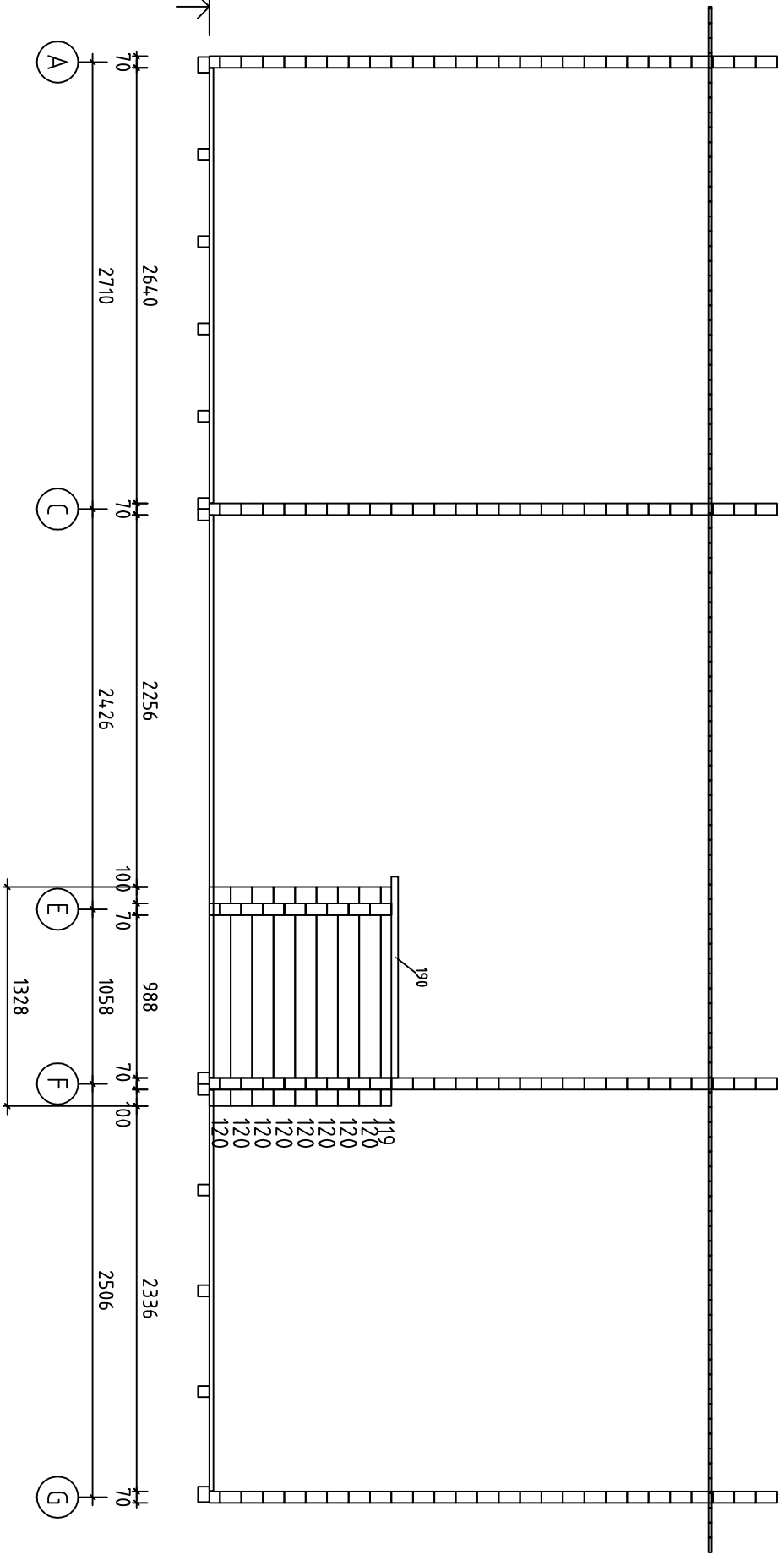



Norrbotten//70/18

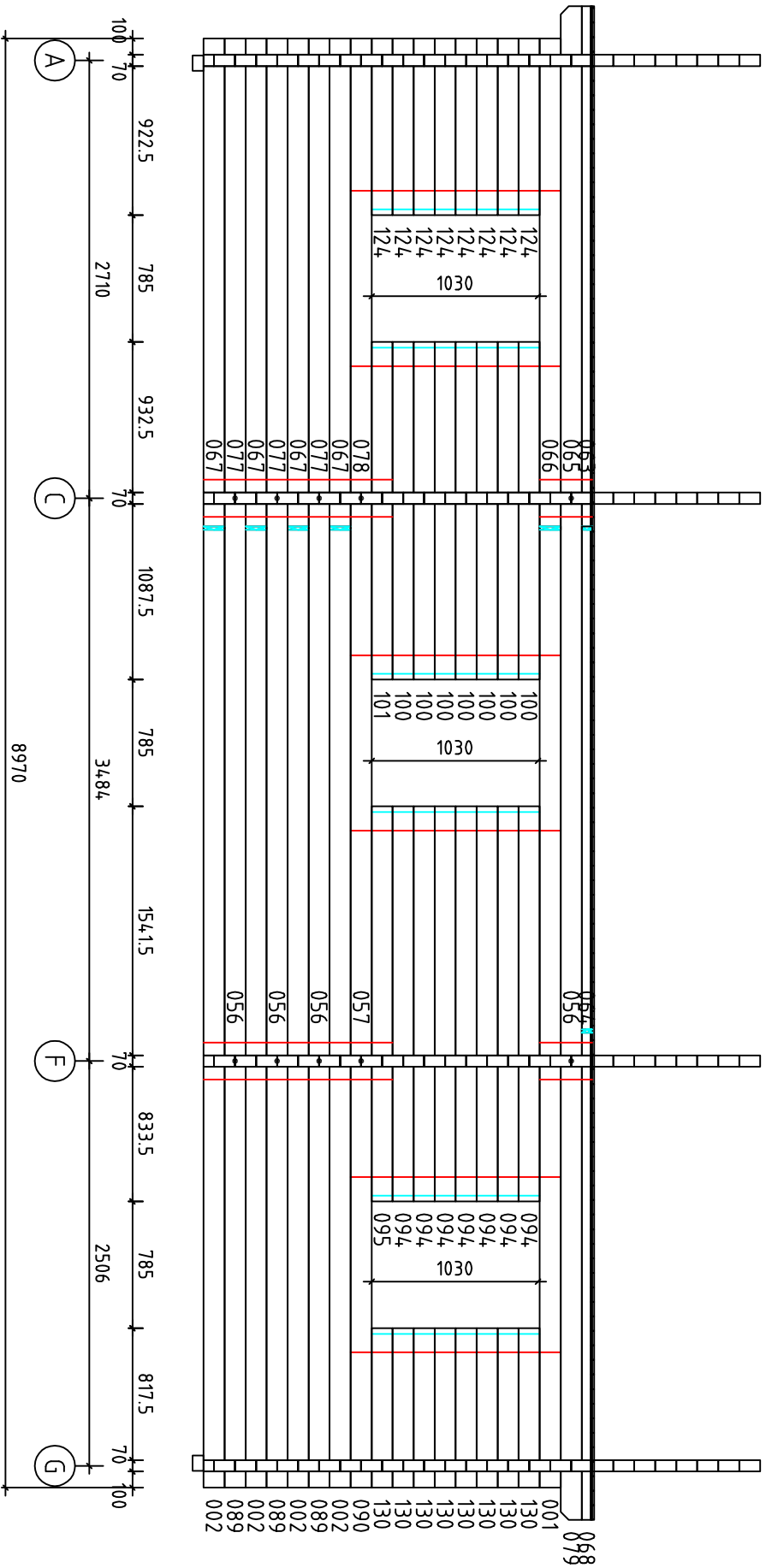

Wand 6 ↗

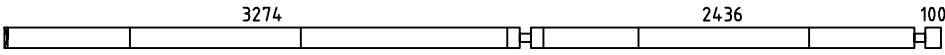
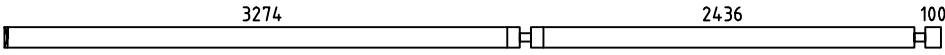
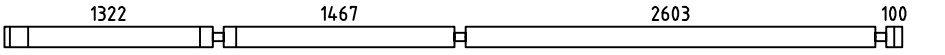
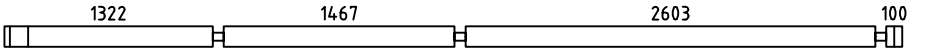
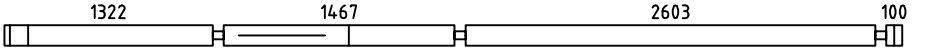
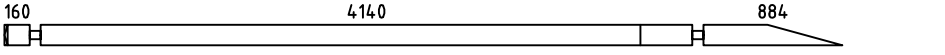
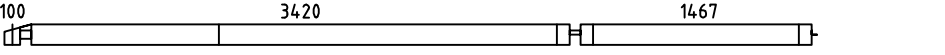
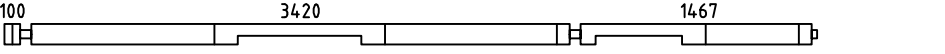
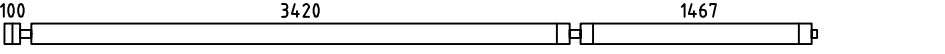
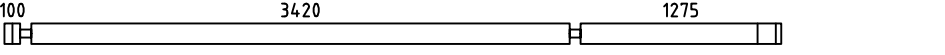
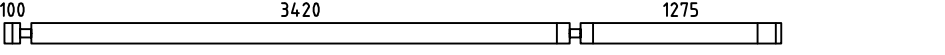

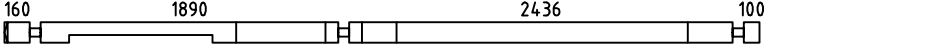
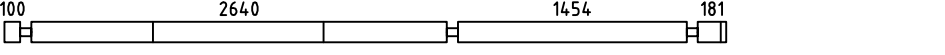
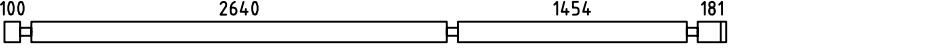
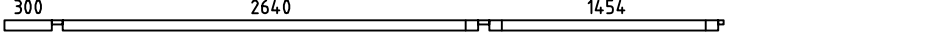
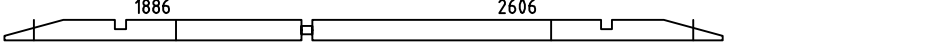
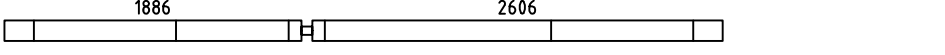
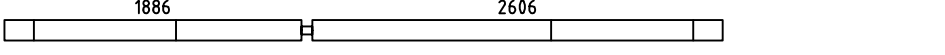
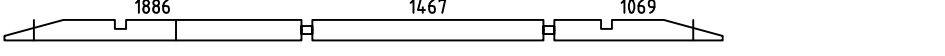
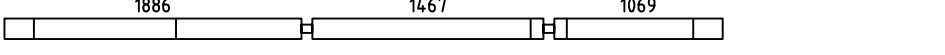
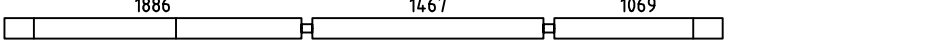
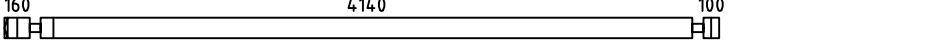
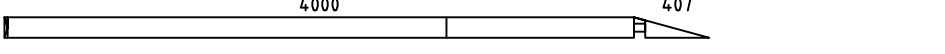
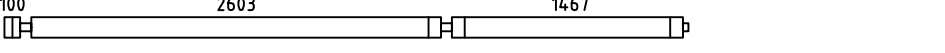

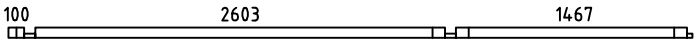
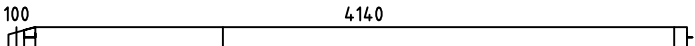
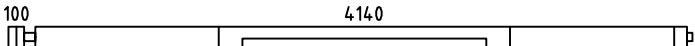
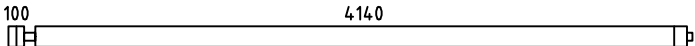
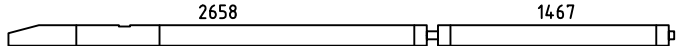
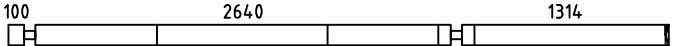
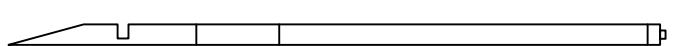
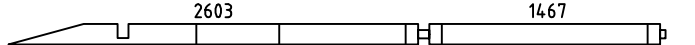
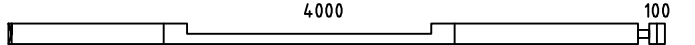
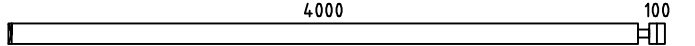
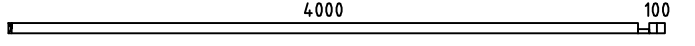
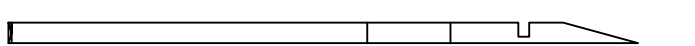
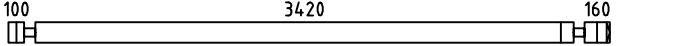
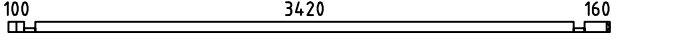
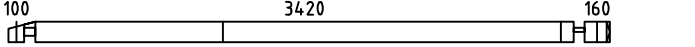
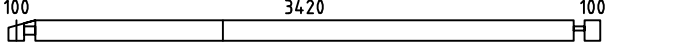
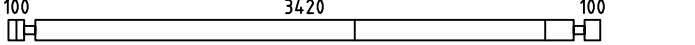
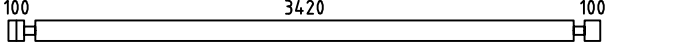
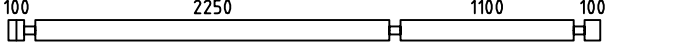
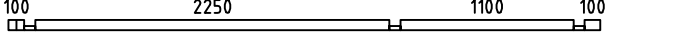
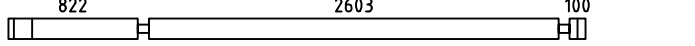
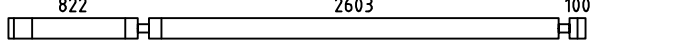
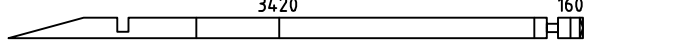
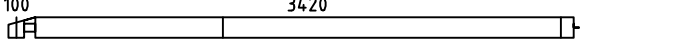
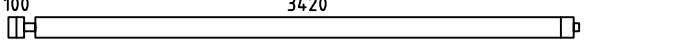
Norrbotten//70/18

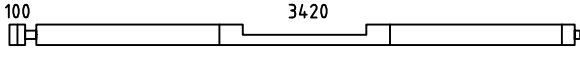
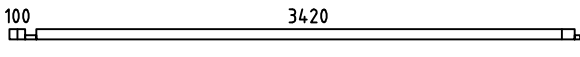
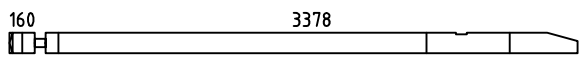
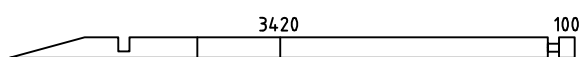
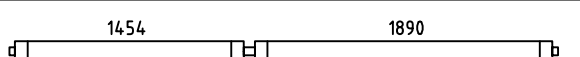
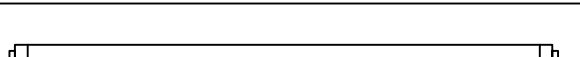
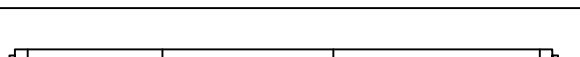
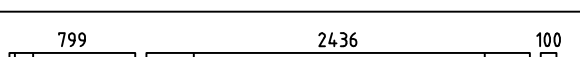
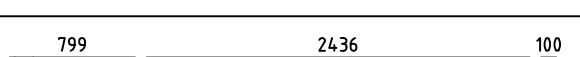
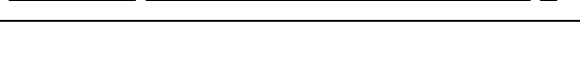
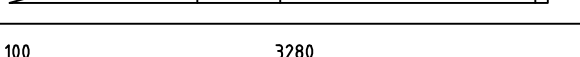
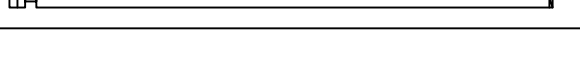
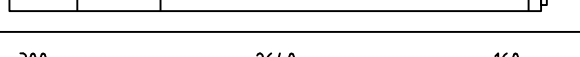
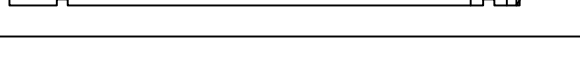
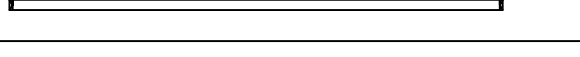
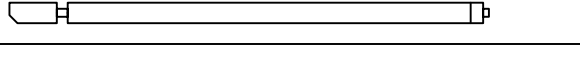
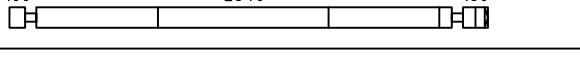
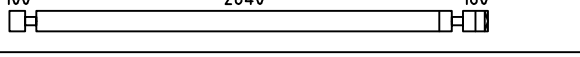
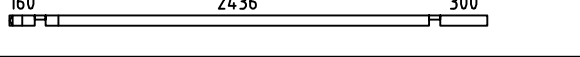
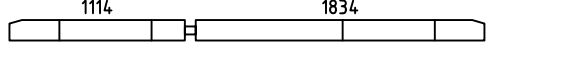
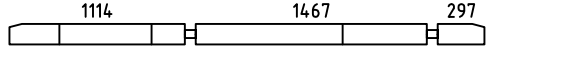
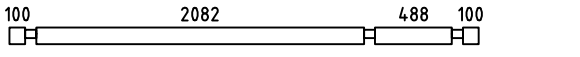
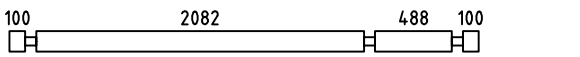

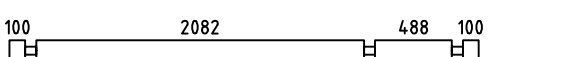

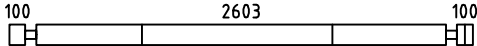
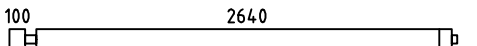
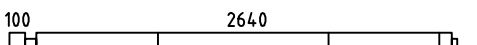
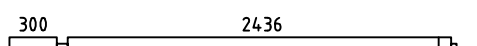
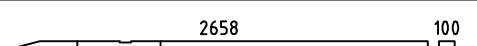
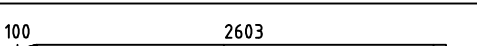
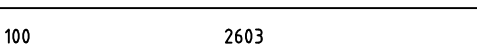
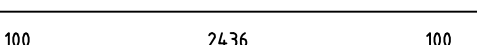
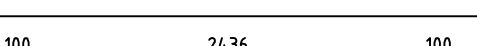
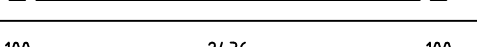
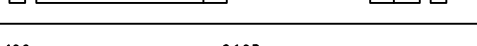
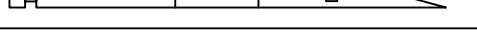
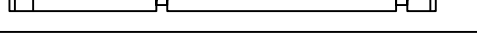
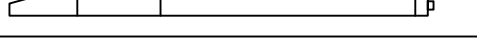
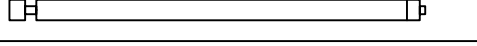
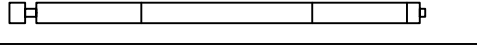
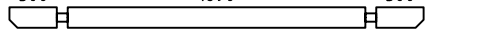
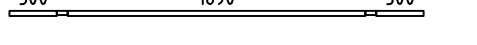
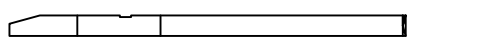
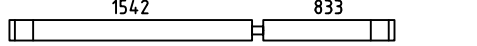
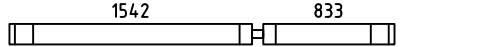
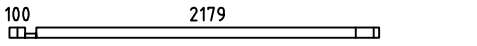
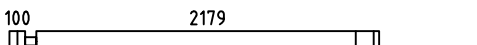
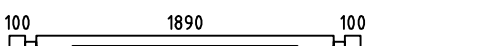
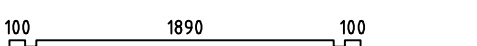



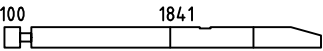
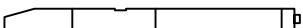
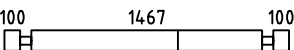
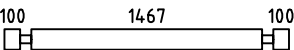
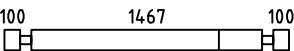
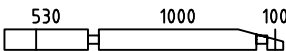
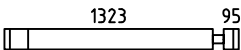
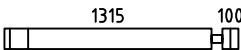
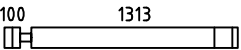
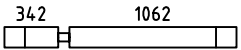
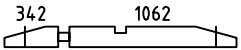
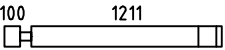
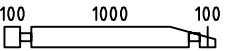
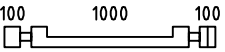
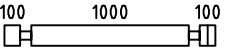
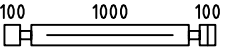
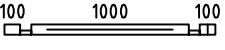
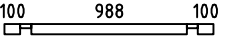
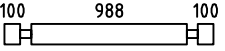
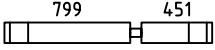
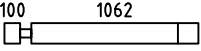
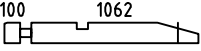
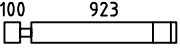
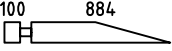

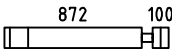
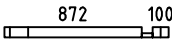
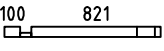
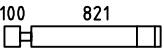
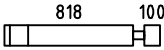
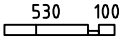
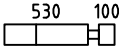
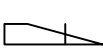
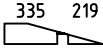
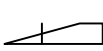
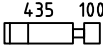
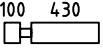
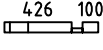
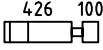
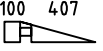
Pos	Norrbotten//70/18	ST	F (mm)	L (mm)
001		1	70x130	5950
002		4	70x130	5950
003		1	70x130	5702
004		1	70x130	5702
005		1	70x130	5702
006		1	70x130	5324
007		1	70x130	5162
008		1	70x130	5162
009		4	70x130	5162
010		6	70x130	4935
011		1	70x130	4935
012		1	70x65	4801
013		1	70x130	4796
014		1	70x130	4585
015		7	70x130	4585
016		1	70x65	4569
017		2	70x130	4562
018		1	70x130	4562
019		1	70x130	4562
020		2	70x130	4562
021		1	70x130	4562
022		1	70x130	4562
023		3	70x130	4540
024		1	70x130	4477
025		5	70x130	4345















Pos	Norrbottnen//70/18	ST	F (mm)	L (mm)
026		1	70x65	4345
027		1	70x130	4345
028		1	70x130	4345
029		4	70x130	4345
030		1	70x130	4230
031		1	70x130	4194
032		1	70x130	4175
033		1	70x130	4175
034		1	70x130	4170
035		1	70x130	4170
036		1	70x65	4170
037		1	70x130	4000
038		2	70x130	3820
039		1	70x65	3820
040		1	70x130	3820
041		1	70x130	3760
042		1	70x130	3760
043		8	70x130	3760
044		8	70x130	3760
045		1	70x65	3760
046		3	70x130	3665
047		1	70x130	3665
048		1	70x130	3650
049		1	70x130	3625
050		9	70x130	3625











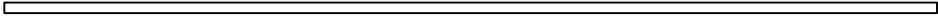
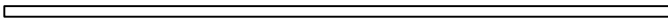
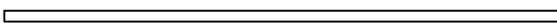



Pos	Norrbotten//70/18	ST	F (mm)	L (mm)
051		1	70x130	3625
052		1	70x65	3625
053		1	70x130	3608
054		1	70x130	3590
055		1	70x130	3484
056		4	70x130	3484
057		1	70x130	3484
058		1	70x130	3475
059		7	70x130	3475
060		2	70x130	3455
061		4	70x130	3450
062		1	70x130	3413
063		1	70x65	3240
064		1	70x65	3134
065		2	70x130	3045
066		1	70x130	3040
067		4	70x130	3040
068		1	70x65	3036
069		2	70x130	3018
070		2	70x130	3018
071		1	70x106	2980
072		48	70x130	2980
073		1	70x14	2980
074		1	70x130	2980
075		1	70x130	2943



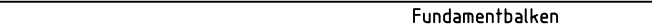
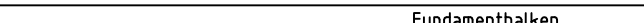
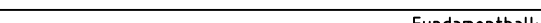

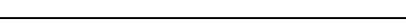
Pos	Norrbotten//70/18	ST	F (mm)	L (mm)
076		1	70x130	2943
077		3	70x130	2845
078		1	70x130	2845
079		2	70x130	2841
080		1	70x130	2828
081		1	70x130	2808
082		5	70x130	2808
083		1	70x106	2776
084		8	70x130	2776
085		1	70x130	2776
086		1	70x130	2773
087		8	70x130	2708
088		1	70x130	2693
089		3	70x130	2641
090		1	70x130	2641
091		1	70x130	2630
092		1	70x33	2630
093		1	70x130	2518
094		7	70x130	2445
095		1	70x130	2445
096		1	70x65	2349
097		16	70x130	2349
098		1	70x130	2230
099		3	70x130	2230
100		7	70x130	2090



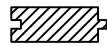

Pos	Norrbotten//70/18	ST	F (mm)	L (mm)
101		1	70x130	2090
102		1	70x130	2011
103		1	70x130	1876
104		1	70x130	1807
105		5	70x130	1807
106		1	70x130	1807
107		1	70x130	1770
108		4	70x130	1488
109		7	70x130	1485
110		7	70x130	1483
111		4	70x130	1474
112		4	70x130	1474
113		16	70x130	1381
114		1	70x130	1340
115		1	70x130	1340
116		1	70x130	1340
117		2	70x130	1340
118		1	70x65	1340
119		1	70x65	1328
120		8	70x130	1328
121		8	70x130	1320
122		1	70x130	1232
123		1	70x130	1232
124		16	70x130	1093
125		1	70x130	1054

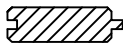
Pos	Norrbotten//70/18	ST	F (mm)	L (mm)
126		16	70x130	1042
127		1	70x65	1042
128		1	70x65	991
129		16	70x130	991
130		8	70x130	988
131		1	70x65	700
132		15	70x130	700
133		2	70x130	624
134		2	70x130	624
135		4	70x130	624
136		8	70x130	605
137		6	70x130	600
138		1	70x65	596
139		16	70x130	596
140		1	70x130	577
141		4	70x130	510
142		4	70x130	510
143		1	70x130	505
144		16	70x130	501
145		1	70x65	501
146		16	70x130	485
147		5	70x120	442
148		5	70x120	442
149		16	70x130	400
150		4	70x90	328

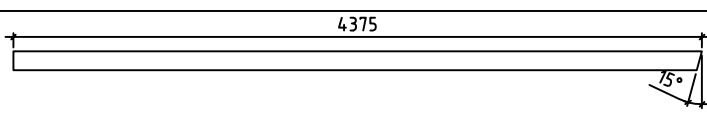
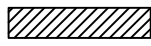
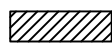
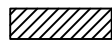
Pos	Norrbotten//70/18	ST	F (mm)	L (mm)
151		4	70x90	328
152	100 131 	1	70x65	301
153	100 131 	16	70x130	301
154	100100 	1	70x65	270
155	100100 	26	70x130	270
156	100100 	1	70x130	270
157	100100 	18	70x130	270
158	100100 	1	70x65	270
159		4	70x59	215
160		4	70x59	215
161		5	70x40	147
162		4	70x40	147
163		1	70x27	100
164	-	4	70x9	33
165	-	4	70x9	33
166	=	5	70x22	70
167	=	4	70x22	70
168		3	70x15	910

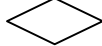
Pos	Norrbottnen//70/18	ST	F (mm)	L (mm)
AR15	Fundamentbalken  Impr.	2	94x68	5926
AR2	Fundamentbalken  Impr.	2	94x68	4240
AR1	Fundamentbalken  Impr.	2	94x68	3520
AR18	Fundamentbalken  Impr.	1	94x68	3348
AR14	Fundamentbalken  Impr.	2	94x68	2646
AR16	Fundamentbalken  Impr.	2	94x68	2578
AR17	Fundamentbalken  Impr.	1	94x68	2374
AR13	Fundamentbalken  Impr.	1	94x68	2020
AR10	Fundamentbalken  Impr.	2	94x68	976
AR9	Fundamentbalken  Impr.	5	68x68	5269
AR7	Fundamentbalken  Impr.	4	68x68	4146
AR12	Fundamentbalken  Impr.	3	68x68	4099
AR6	Fundamentbalken  Impr.	4	68x68	3426
AR4	Fundamentbalken  Impr.	7	68x68	3379
AR5	Fundamentbalken  Impr.	4	68x68	2562
AR8	Fundamentbalken  Impr.	5	68x68	2209
AR3	Fundamentbalken  Impr.	5	68x68	1443
AR11	Fundamentbalken  Impr.	2	68x68	976

Pos	Norrbotten//70/18		ST	F (mm)	L (mm)
169	Fussbodenbretter		67	90x26	2636
170			17	90x26	2078
171			45	90x26	3410
172			9	90x26	4005
173			21	90x26	2469
174			8	90x26	2832
175			20	90x26	3642
176			44	90x26	2432
177			12	90x26	3447
178			12	90x26	2274
179	Terrassenbretter	Impr. 	11	90x26	1958
180	Dachbretter		182	90x20	4330
			30	90x20	3990
			30	90x20	1450
181	Abdeckleiste			20x40	85lfm
182	Giebelbretter	 	4	20x120	4375
			2	20x120	1151
183	Giebeldeckbretter		4	20x90	4375
			2	20x90	1151
184	Traufenbrett		1	20x90	2508
	Traufenbrett		1	20x90	2630
	Traufenbrett		1	20x90	4236
	Traufenbrett		2	20x90	4685

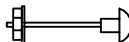
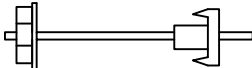
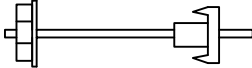
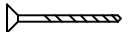
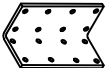
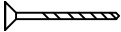
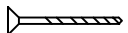
Pos	Norrbotten//70/18		ST	F (mm)	L (mm)
185	Traufenleiste		1	40x40	2508
			1	40x40	2630
			1	40x40	4236
			2	40x40	4685
186	Giebelsegment		2		
187	Dübel		576		
188	Handlauf		1	40x140	1430
189			1	40x140	800
190	Theke		1	40x500	1220
191	Bolzen für Dachbalken		72	M12	100
G1	Gewindesttift12		7		2400
G2	Gewindestift12		2		2105
KMPL.	Schrauben für Brettern und Dachleisten 4x50		3300		
	Vinkel		80	60x60x60	
	Schrauben für Vinkel 4x40		640		
	Schrauben für Fundament 6x150		60		
Kood	Materjal	File	frökk.dwg	Leht	9/9

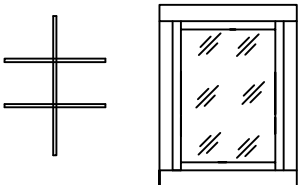
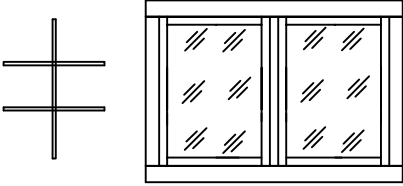
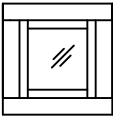
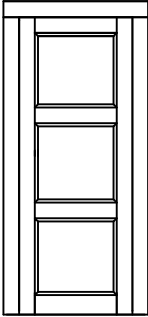
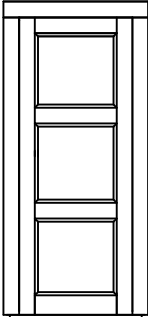
Pos	Norrbottnen//70/18		ST	F (mm)	L (mm)
F1	Fenster 765x990 			3L+2R	
F2	BC	Fenster 1530x990 	2		
F3	Fenster 530x530 		1L		
T1	Tür 890x2090 			2L+2R	
T2	Tür 890x2090 		1R		
Kood	Materjal	File	trükk.dwg	Leht	9/9